

KT03571

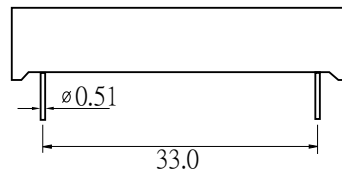

CODE K

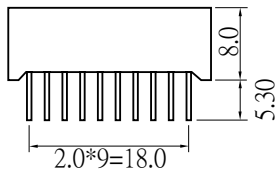
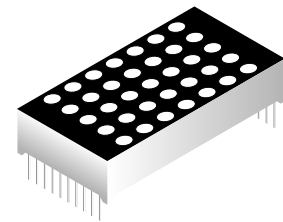
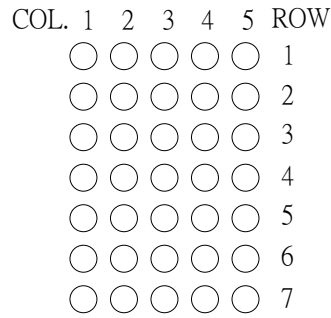
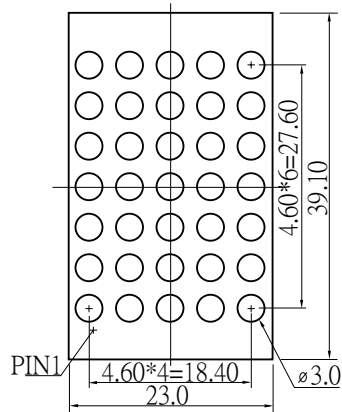
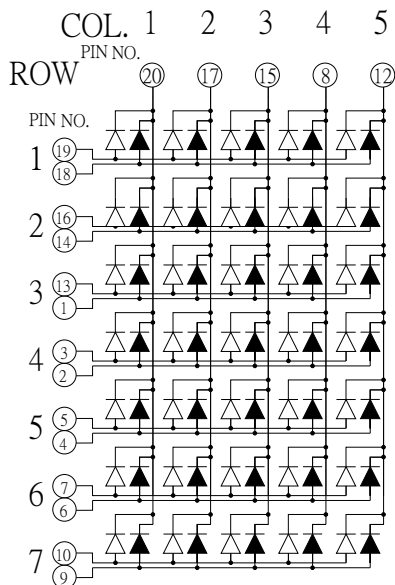

11 NO PIN ◀ = ORANGE
 ◀ = GREEN

CODE H

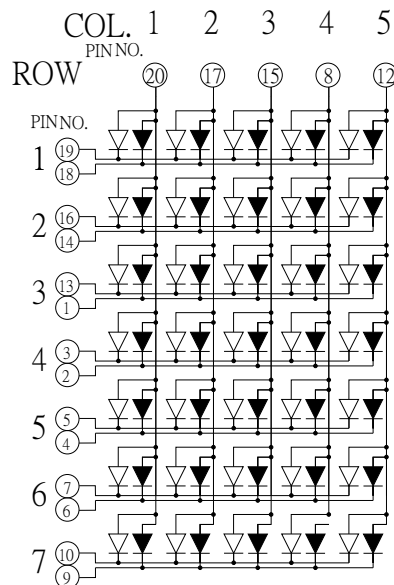

11 NO PIN ◀ = ORANGE
 ◀ = GREEN